

Features:

- Highest Flux
- High reliability and Very long operating life
- Low voltage DC operated
- More Energy Efficient than Incandescent and most Halogen lamps
- NO UV
- Superior ESD protection
- RoHS Compliant



ATTENTION
OBSERVE PRECAUTIONS
FOR HANDLING
ELECTROSTATIC
DISCHARGE
SENSITIVE
DEVICES

Typical Applications:

- Lighting
- Portable
- Automobile
- Decorations

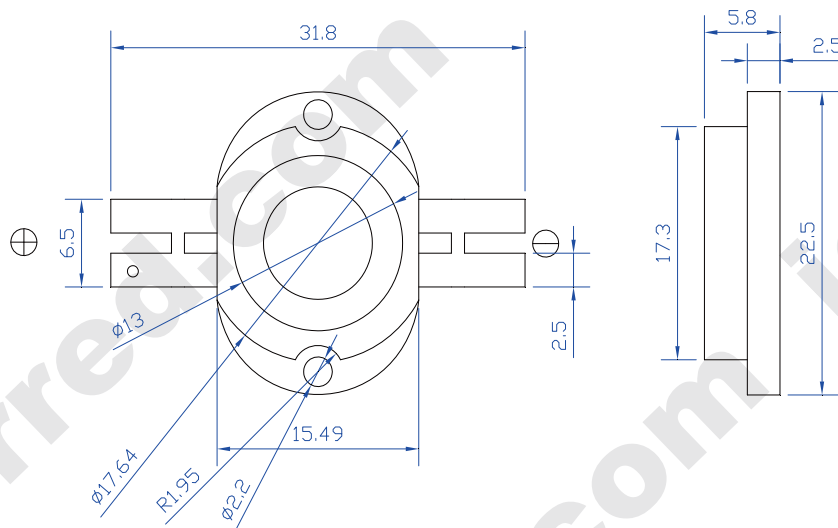

NOTE:

- All dimensions are millimeter.
- Tolerance is $\pm 0.1\text{mm}$ unless otherwise noted.
- It is strongly recommended that the temperature of lead be not higher than 60°C .
- The appearance and specifications of the product may be modified for improvement without notice.

Absolute maximum ratings (Ta = 25°C)

Parameter	Symbol	Test Condition	Value		Unit
			Min.	Max.	
DC Forward Current	IF	----	----	1800	mA
Peak Pulse Current	Ipeak	Duty=0.1mS, 1kHz	----	2800	mA
Power Dissipation	Pd	----	----	20	W
LED Junction Temperature	Tj	----	----	120	°C
Operating Temperature	Topr	----	-25	+80	°C
Storage Temperature	Tstr	----	-40	+100	°C
ESD Sensitivity	----	HBM	8000	----	V
Soldering Temperature	----	----	260°C for 5 Seconds max		

Electrical and optical characteristics (Ta = 25°C)

Parameter	Symbol	Test Condition	Value			Unit
			Min.	Typ.	Max.	
Forward Voltage	VF	IF = 1400mA	9.0	10.0	13.0	V
Luminous Flux	Φv		----	500	----	lm
Viewing Angle	2θ 1/2		----	120	----	Deg.
Dominant Wavelength	λd		620	----	630	nm

Luminous Flux Bins (Ta = 25°C)**Unit: lm**

Bin	X	Y	Z	A2
Min	360	400	450	500
Max	400	450	500	600

Note

1. Flux is measured with an accuracy of ±15%
2. CCT is measured with an accuracy of ± 200K
3. Dominant Wavelength is measured with an accuracy of ± 1.5nm
4. Forward Voltage is measured with an accuracy of ± 0.15V